



947



Body 1: All Body Fabric



All Power Items unless specified feature a Zero Gravity reclining mechanism which has been designed to suspend the body in a neutral position while simultaneously elevating the feet so they are in alignment with the heart, creating an almost weightless sensation allowing for deeper relaxation.

PIECES

Sofa Height : 43" Seat Height: 20" Seat Depth: 20" Arm Height: 25"

SOFAS

51 - Dual Reclining Sofa
L: 81" x D: 39"

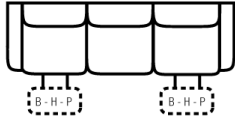

85 - Dual Recl. Cons. Loveseat
L: 72" x D: 39"

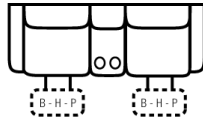

2 Power Outlets plus
2 USB outlets available in console.

52 - Dual Reclining Loveseat
L: 58" x D: 39"

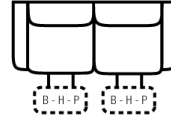

48 - Dual Glide Recl. Cons. Love
L: 72" x D: 39"

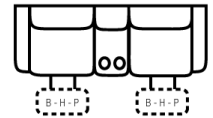

2 Power Outlets plus
2 USB outlets available in console.
No Zero Gravity

CHAIRS

53 - Reclining Chair
L: 33" x D: 39"

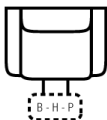

83 - Swivel Rocker Recliner
88 - Glider Recliner
L: 33" x D: 39"

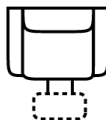

Manual Only
Power Options and Zero Gravity
are not available on these items

84 - Rocker Recliner
L: 33" x D: 39"

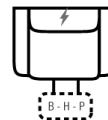

No Zero Gravity

87 - Swivel Glider Recliner
L: 33" x D: 39"

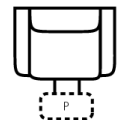

No Zero Gravity

SECTIONALS

70 - Wedge
L: 50" x D: 50"



Power Options
are not available on this item

71 - Armless Recl. Chair
L: 25" x D: 38"

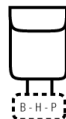

73L* - 1 Arm Standard Recliner
L: 29" x D: 38"



79 - Armless Stationary Chair
L: 25" x D: 38"



Power Options
are not available on this item

80 - Stationary Console
L: 14" x D: 38"



2 Power Outlets plus
2 USB outlets available in
console.

* Available in both Left and Right configurations

All motion Items unless noted are available in Manual as well as 3 different power options that include USB charging:

P- Featuring Power Recline

H- Featuring Power Adjustable Headrest & Power Recline

B- Featuring Power Adjustable Lumbar Support, Power Headrest & Power Recline

CONFIGURATIONS

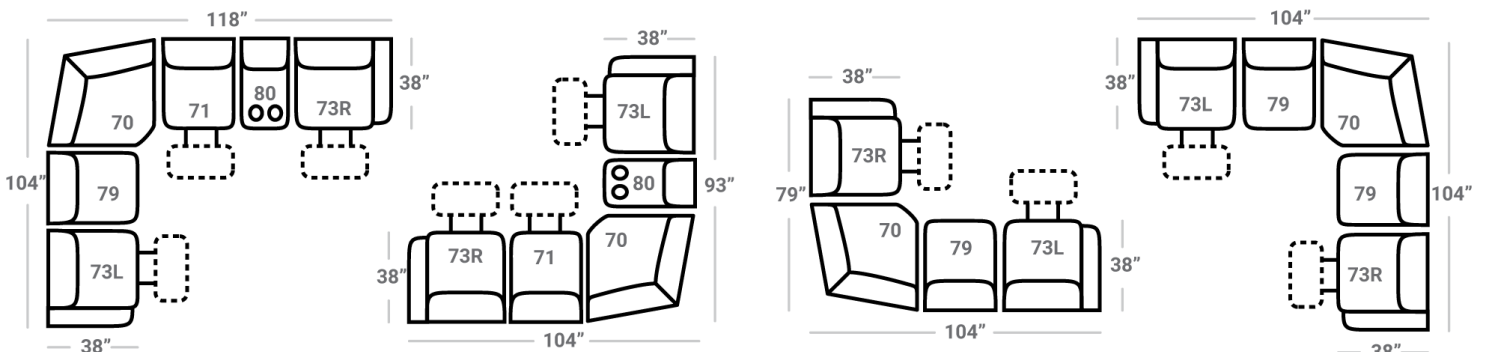

Dimensions are approximate and subject to change.

Printed: 7/27/2024