



Body 1: Main Body Fabric & Backs of Pillows Including Welt – Contrast 1 : Pillow Face

PIECES

Sofa Height: 38" Seat Height: 21" Seat Depth: 21" Arm Height: 27"

SOFAS

01 - Sofa
15 - Queen Sleeper
L: 88" x D: 37"

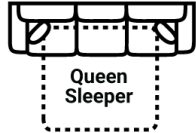

71 - Loft Sofa
14 - Full Sleeper
L: 76" x D: 37"

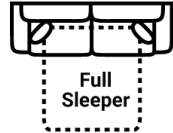

02 - Loveseat
16 - Twin Sleeper
L: 64" x D: 37"

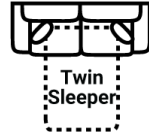

65 - Sofa Chaise Qn. Slpr.
64 - Sofa Chaise w/ Stor. Qn. Slpr.
L: 88" x D: 62"

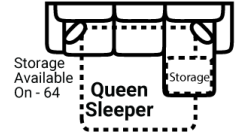

03 - Chair
L: 40" x D: 37"



81 - Large Sofa
L: 97" x D: 37"

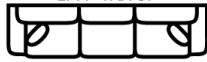

61 - XL Sofa
L: 112" x D: 37"

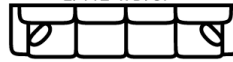

33 - Sofa Chaise
97 - Sofa Chaise w/ Stor.
L: 88" x D: 62"



Sofa Chaise cushions are reversible and can be moved with the ottoman to the opposite side

SECTIONALS

10L - Tux Sofa *
L: 98" x D: 37"

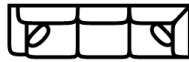

11L - 1 Arm Sofa *
L: 84" x D: 37"

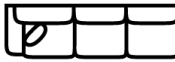

45R - 1 Arm Sofa Chaise *
50R - 1 Arm Sofa Chaise w/ Storage*
L: 84" x D: 62"

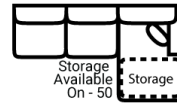

Sectional Chaise cushions are reversible and can be moved with the ottoman to other sectional pieces with arms

95L - Tux Loveseat *
L: 73" x D: 37"

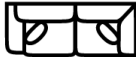

12L - 1 Arm Loveseat *
L: 60" x D: 37"

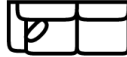

23 - Armless Loveseat
L: 62" x D: 37"



OTTOS

17 - Corner Chair
L: 37" x D: 37"



24L - 1 Arm Chair *
L: 34" x D: 37"



18 - Armless Chair
L: 26" x D: 37"



54 - Cuddle Corner
L: 48" x D: 48"



41 - Corner Wedge
L: 52" x D: 52"



21L - 1 Arm Chaise *
L: 35" x D: 60"



75R - 1 Arm Angled Cuddler *
L: 63" x D: 66"



29 - Cocktail Otto.
L: 39" x D: 39"



35 - Storage Otto.
L: 37" x D: 37"



43 - Rect. Otto.
47 - Rect. Storage Otto.
L: 50" x D: 28"

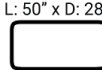

04 - Ottoman
L: 30" x D: 20"



For Sectional Sleepers Please see Style 543

* Available in both Left and Right configurations

CONFIGURATIONS

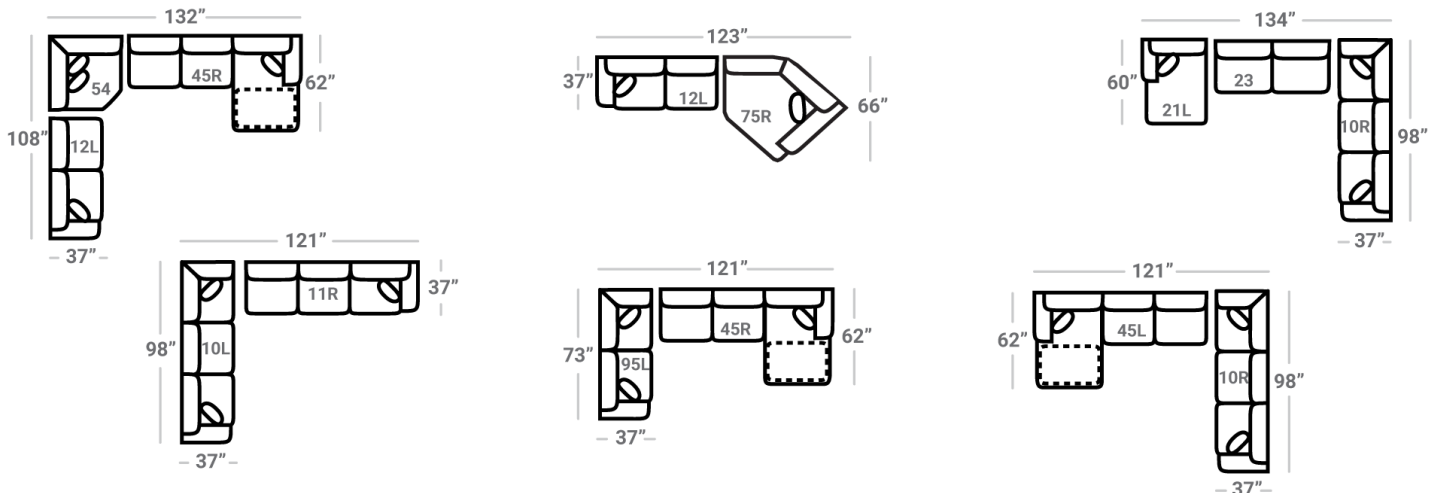

Dimensions are approximate and subject to change.

Printed: 4/3/2025