



631 think LOCAL

www.stantonsofas.com



Body 1: Main Body Fabric – Contrast 1: Both Sides of Pillows – Contrast 2: Both Sides of Pillows

PIECES

Sofa Height: 37" Seat Height: 21" Seat Depth: 21" Arm Height: 25"

SOFAS

01 - Sofa
15
Queen Sleeper
L: 85" x D: 39"

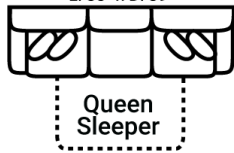

02 - Loveseat
16
Twin Sleeper
L: 61" x D: 39"

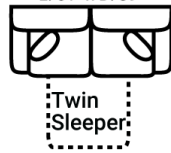

03 - Chair
L: 38" x D: 39"

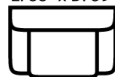

33 - Sofa Chaise
97 - Sofa Chaise w/ Stor.
L: 85" x D: 67"

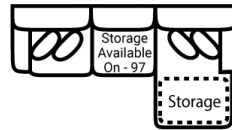

Sofa Chaise cushions are reversible and can be moved with the ottoman to the opposite side

65 - Sofa Chaise Qn. Slpr.
64 - Sofa Chaise w/ Stor. Qn. Slpr.
L: 85" x D: 67"

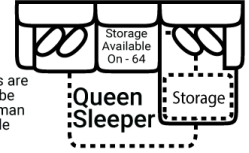

SECTIONALS

10L - Tux Sofa *
L: 93" x D: 39"

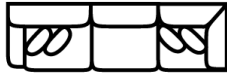

11L - 1 Arm Sofa *
L: 79" x D: 39"

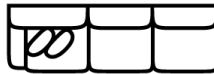

32 - Armless Sofa
L: 72" x D: 39"



45R - 1 Arm Sofa Chaise *
50R - 1 Arm Sofa Chaise w/ Storage*
L: 79" x D: 67"

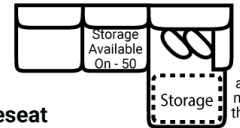

Sectional Chaise cushions are reversible and can be moved with the ottoman to other sectional pieces with arms

95L - Tux Loveseat *
L: 68" x D: 39"

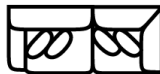

12L - 1 Arm Loveseat *
L: 54" x D: 39"

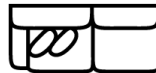

31 - Armless Loveseat
L: 48" x D: 39"

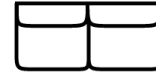

17 - Corner Chair
L: 39" x D: 39"



18 - Armless Chair
L: 24" x D: 39"



24L - 1 Arm Chair *
L: 31" x D: 39"



41 - Corner Wedge
L: 50" x D: 50"



21L - 1 Arm Chaise *
L: 35" x D: 67"



75R - 1 Arm Angled Cuddler *
L: 64" x D: 67"

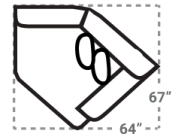

OTTOMANS

67 - XL Sq. Cktl. Otto.
L: 50" x D: 50"

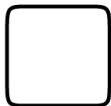

29 - Cocktail Otto.
L: 39" x D: 39"



35 - Storage Otto.
L: 37" x D: 37"



04 - Ottoman
L: 31" x D: 21"



43 - Rect. Otto.
47 - Rect. Storage Otto.
L: 49" x D: 27"



* Available in both Left and Right configurations

CONFIGURATIONS

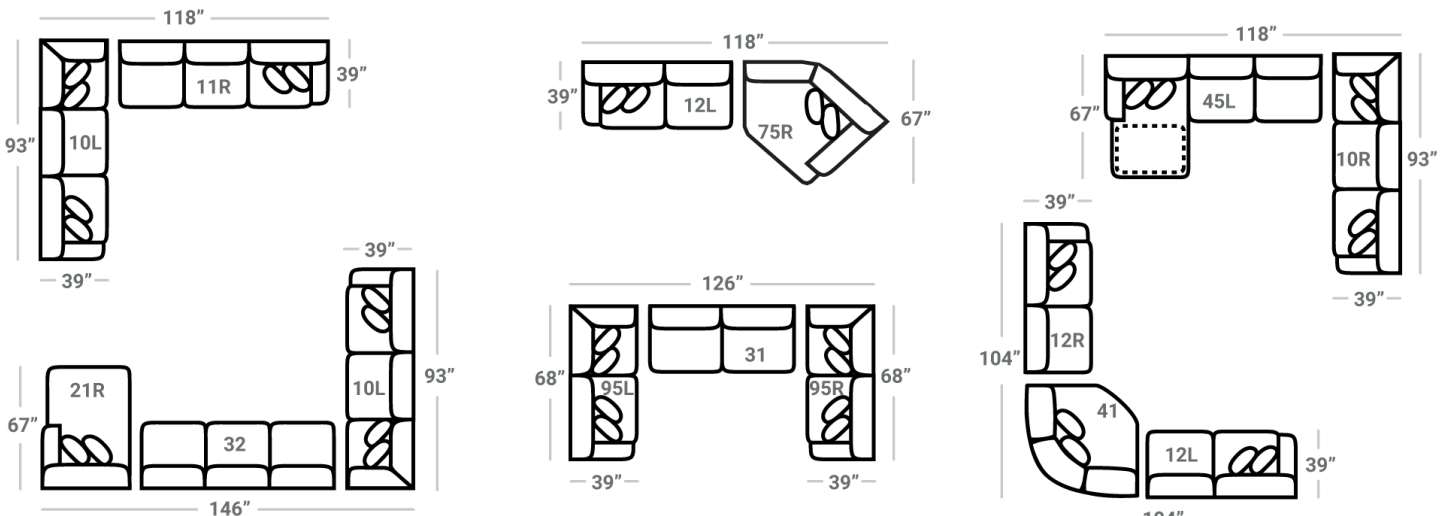

Dimensions are approximate and subject to change.

Printed: 3/7/2026