



Body 1: Main Body Fabric -- Contrast 1: Both Sides of Pillows -- Contrast 2: Both Sides of Pillows

PIECES

Sofa Height: 37" Seat Height: 21" Seat Depth: 21" Arm Height: 25"

SOFAS

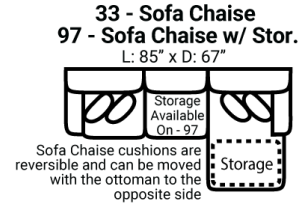
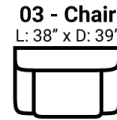
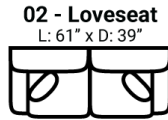
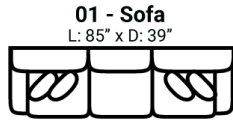

SECTIONALS

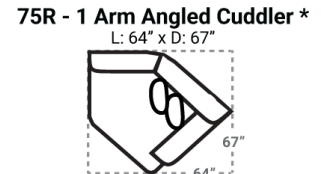
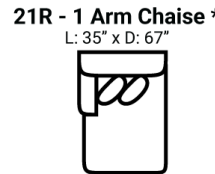
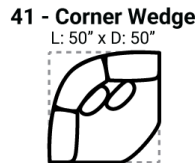
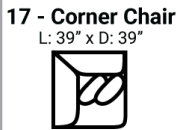
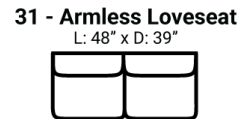
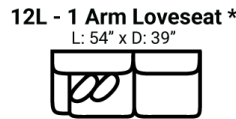
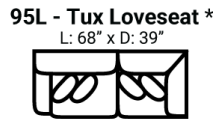
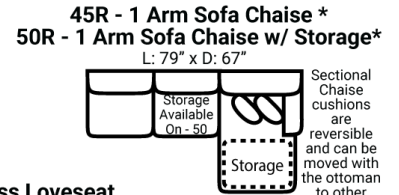
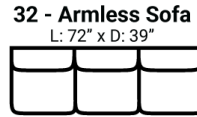
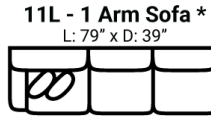
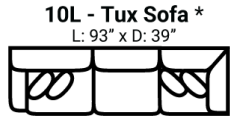

OTTOMOS

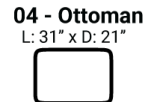
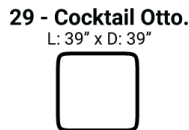
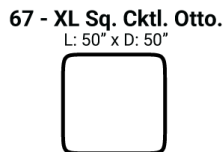

* Available in both Left and Right configurations

CONFIGURATIONS

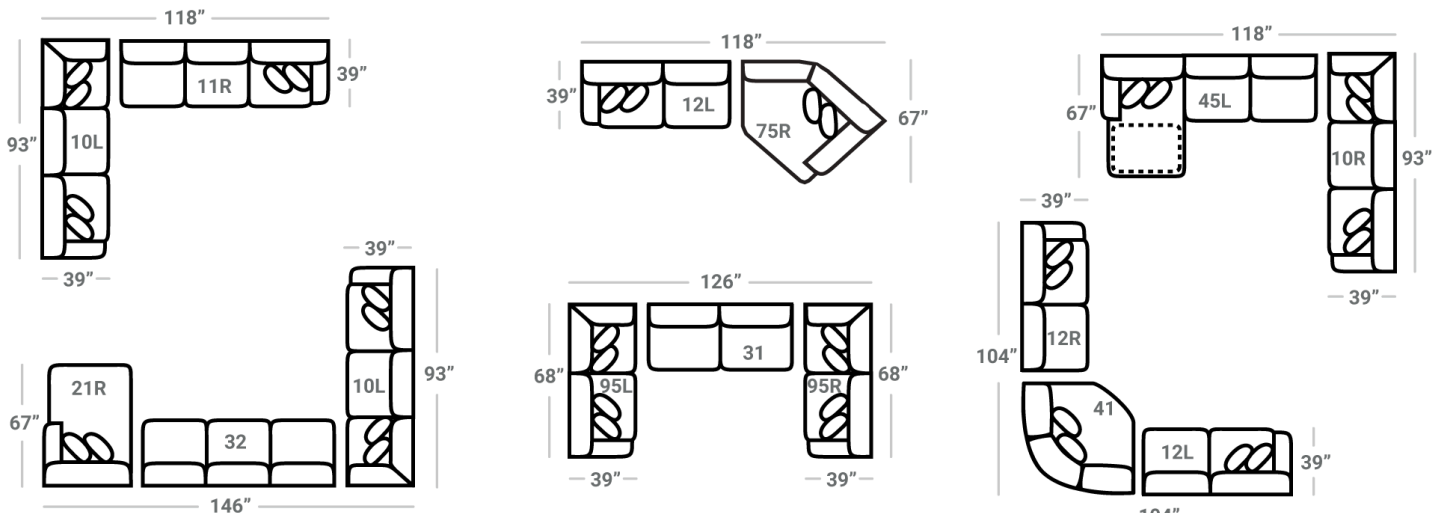

Dimensions are approximate and subject to change.