



376 think LOCAL

www.stantonsofas.com



Body 1: All Body Fabric – Contrast 1 : Both Sides of Pillows Including Welt – Contrast 2 : Both Sides of Pillows Including Welt

PIECES

Sofa Height : 38" Seat Height: 20" Seat Depth: 26" Arm Height: 26"

SOFAS

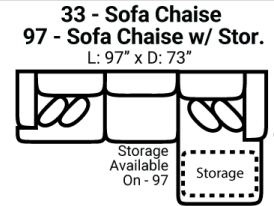
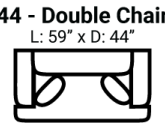
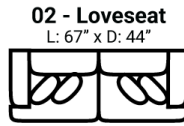
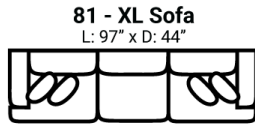
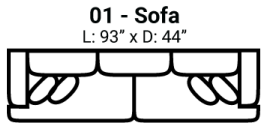

Sofa Chaise cushions are reversible and can be moved with the ottoman to the opposite side

SECTIONALS

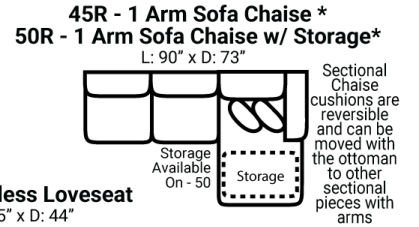
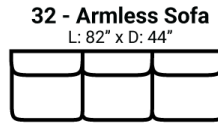
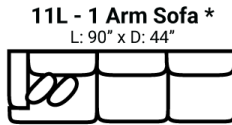
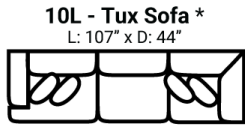

Sectional Chaise cushions are reversible and can be moved with the ottoman to other sectional pieces with arms

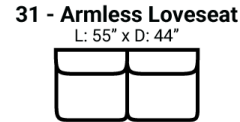
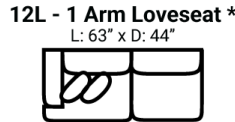
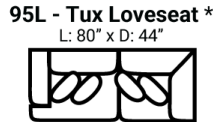

OTTOMOS

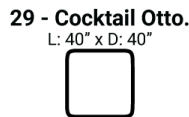
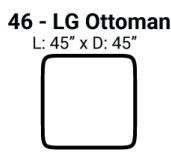
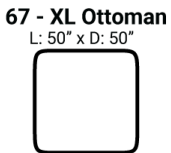
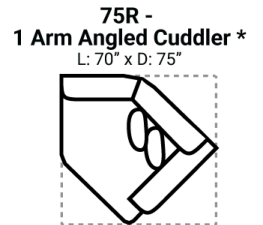
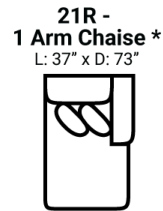
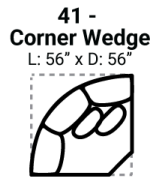

* Available in both Left and Right configurations

CONFIGURATIONS

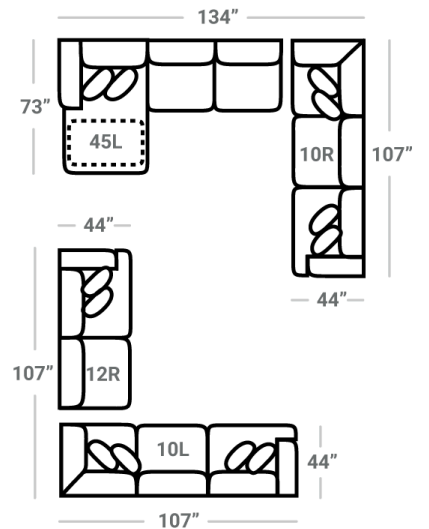
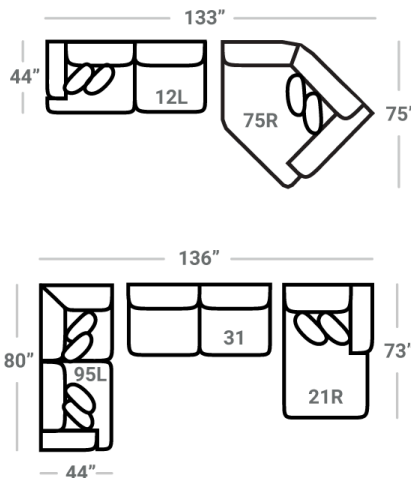
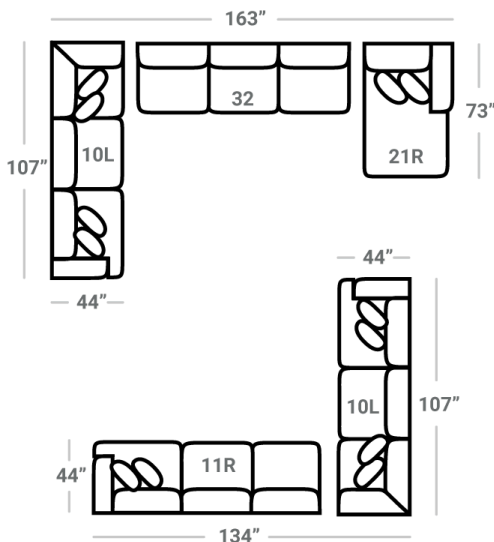

Dimensions are approximate and subject to change.

Printed: 4/19/2026